

STRATIGRAPHY AND SEDIMENTOLOGY OF MIDDLE AND UPPER SILURIAN  
ROCKS AND AN ENIGMATIC DIAMICTITE, SOUTHEASTERN NEW YORK.

ANTHONY R. PRAVE and MOSES L. ALCALA  
Dept. of Earth and Planetary Sciences  
The City College of New York  
New York, NY 10031

JACK B. EPSTEIN  
U.S. Geological Survey  
Reston, VA 22092

INTRODUCTION

During much of the Silurian Period, sedimentation patterns throughout the northern Appalachian Basin record west to northwest spreading of terrigenous and marginal marine clastics into a deeper water mud and carbonate basin (Cotter, 1988; Middleton, 1987). The clastics were derived from highlands uplifted during the Taconic orogeny in eastern Pennsylvania and southeastern New York. By the Late Silurian, active tectonism had ceased so that the (dis)equilibrium between sediment influx, basin subsidence and relative changes in sea level were the probable first-order variables controlling facies distribution.

STRATIGRAPHY

The middle to Upper Silurian rocks to be examined during the field trip crop out along a northeast-trending belt of exposures in southeastern New York (Fig. 1). The stratigraphic successions at the extremities of this belt are firmly established (Figs. 2 & 3). In northeastern areas the stratigraphy consists of the Shawangunk Formation, High Falls Shale, Binnewater Sandstone of Hartnagel (1905) and Rondout Formation whereas in southwestern areas it is the Shawangunk Formation, Bloomsburg Red Beds, Poxono Island Formation and Bossardville Limestone. Recent mapping by Epstein and Lyttle (1987) indicates that the facies mosaic between those two areas is more complicated than previously reported. They established the stratigraphic framework presented on this field trip as well as determined the structural effects of Taconic and Alleghanian deformations. This field trip is concerned with facies interpretation. The localities to be visited are shown on Figure 1 and generalized descriptions of the stratigraphic units are given in Table 1.

As shown on Figure 2, the Silurian succession thins markedly from Pennsylvania toward southeastern New York. A quartz arenite (Tuscarora Sandstone) and sandstone-shale unit (Clinton Formation) developed in central Pennsylvania undergo a facies change eastward (eastern Pennsylvania) to quartzite-conglomerate units (Weiders, Minsi and Tammany Members) and an intervening

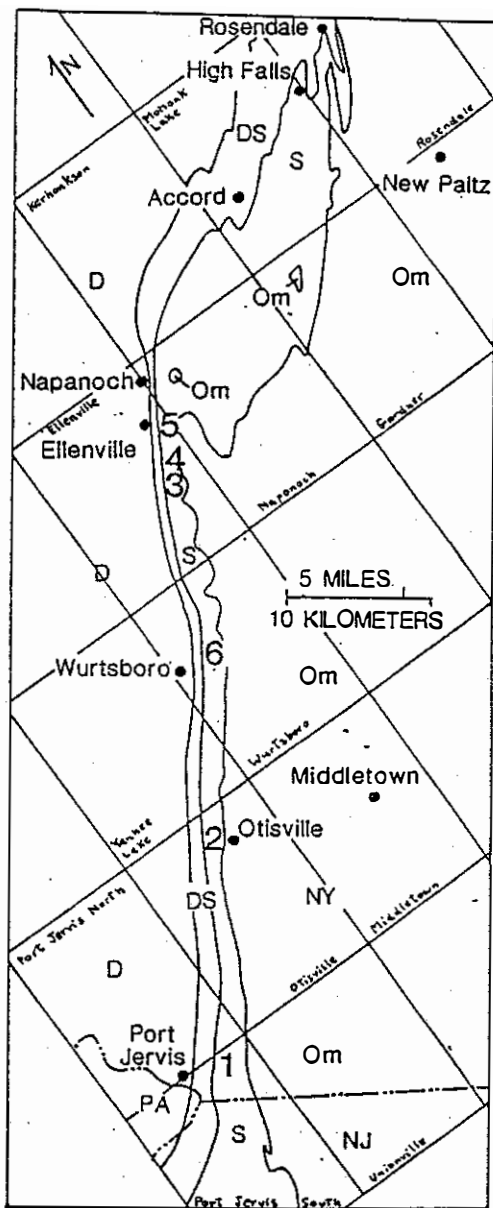

Figure 1. Generalized geologic map of part of southeastern NY showing field trip stop numbers and 7.5' quadrangle coverage.

D-Hamilton Group and younger strata.

DS-Rondout Fm through Onondaga Limestone.

S-High Falls Shale, Bloomsburg Red Beds, Bloomsburg and Shawangunk tongues, Shawangunk Fm.

Om-Martinsburg Formation.

unit containing appreciable shale and some red beds (Lizard Creek Member). Together these members constitute the Shawangunk Formation as described by Epstein and Epstein (1972). The shales of the Lizard Creek Member become less abundant in north-central New Jersey and the member cannot be mapped to the northeast, although scattered intervals of shale, some containing red beds, at various levels within the Shawangunk persist into southeastern New York. The "Otisville Shale" (see Fig. 3), named by Swartz and Swartz (1931) for a unit thought to contain enough shale to be a distinct formation near Otisville, NY (Stop 2), fails the test of mappability and Epstein and Lyttle (1987) suggested that the term be abandoned.

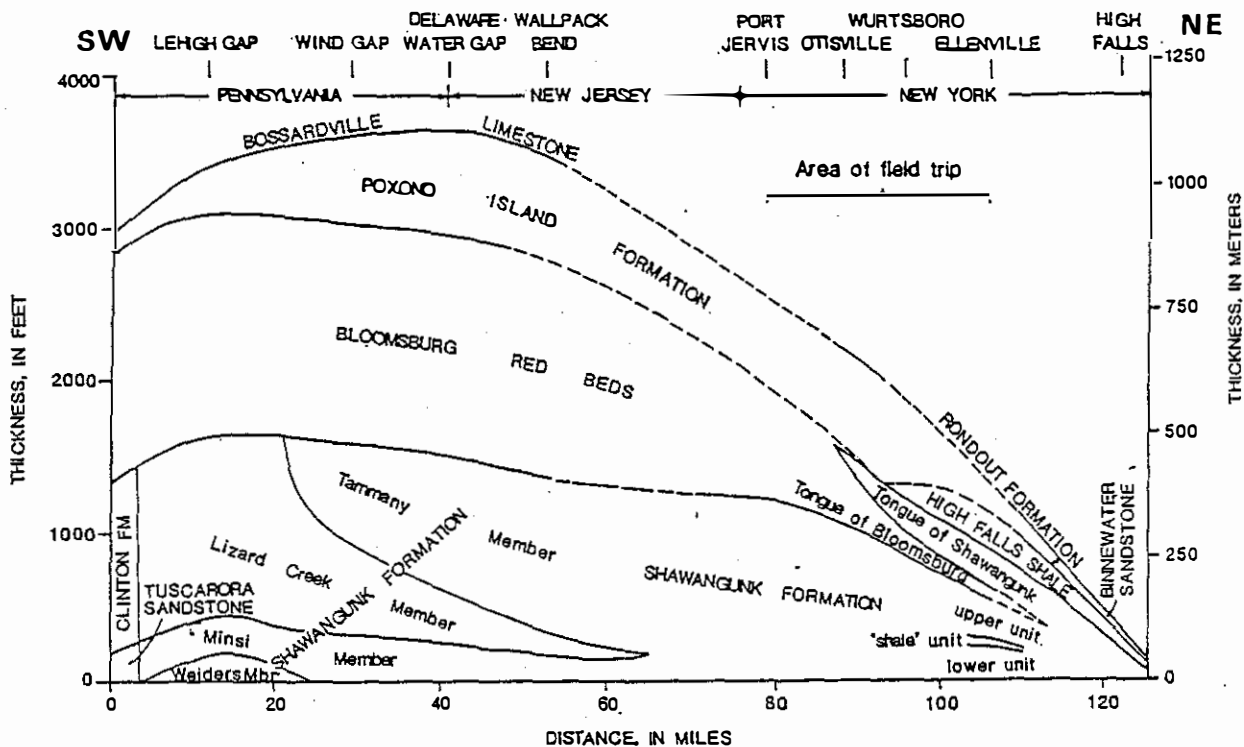

Figure 2. Stratigraphic section of Silurian rocks from Lehigh Gap, PA, to High Falls, NY. Field trip area is shown. Modified from Epstein and Lyttle (1987). Dashes indicate poor exposures of contact.

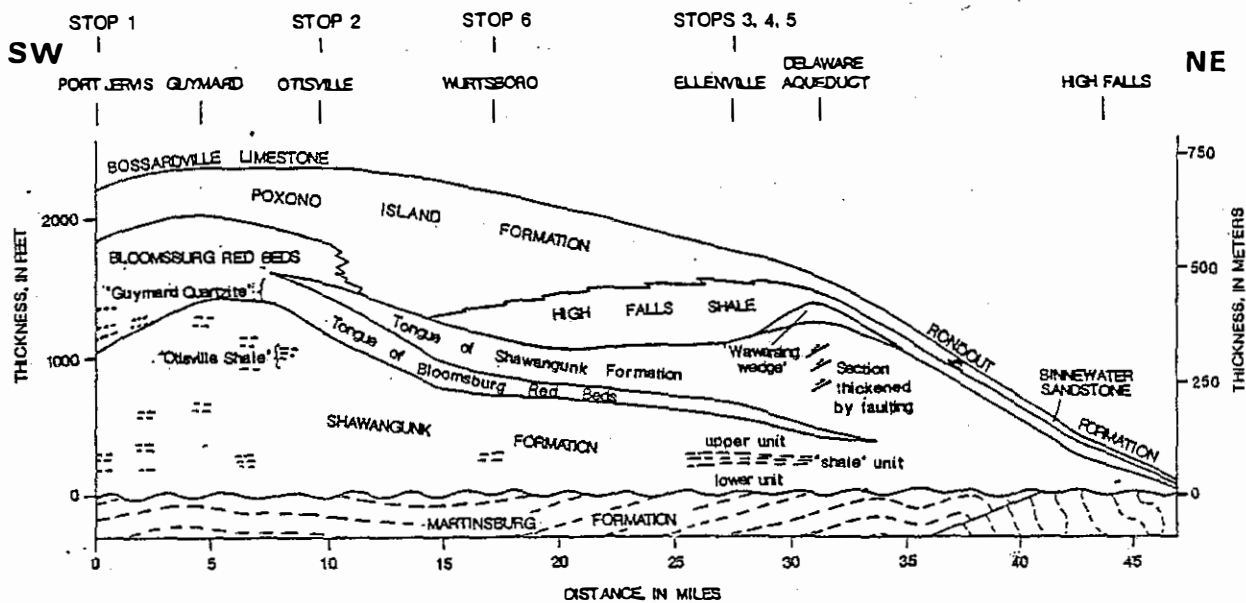

Figure 3. Stratigraphic section of Silurian rocks from Port Jervis to High Falls, NY. Field trip stops are shown. Modified from Epstein and Lyttle (1987).

TABLE 1: GENERALIZED STRATIGRAPHY IN FIELD TRIP AREA.

POXONO ISLAND FM (U. Sil.)-poorly exposed gray and green dolomite and shale, possible red shale near base. 0-150 m thick.

HIGH FALLS SHALE (U. Sil.)-type locality consists of red and green calcareous shale and siltstone; some argillaceous carbonate; 0-25 m thick. In field trip area it consists of fine to medium, trough cross-bedded sandstone with thin red and gray shale layers.

BLOOMSBURG RED Beds (U. Sil.)-red and gray shale, siltstone and sandstone in meter-scale fining-upward cycles. 0-335 m thick.

SHAWANGUNK TONGUE (U. Sil.)- crossbedded (light-dark laminae) fine to medium quartzite with some pebbly quartzite; minor green shale and siltstone; rare red shale. 0-105+ m thick.

BLOOMSBURG TONGUE (U. Sil.)-reddish and grayish siltstone, shale and fine to pebbly sandstones in meters-scale fining-upward cycles. 0-50 m thick.

SHAWANGUNK FM (M. Sil.)-crossbedded, tabular to channeled quartzite and conglomerate; minor siltstone and shale, in places red and green; base is an unconformity. 0-425 m thick.

DIAMICTITE-COLLUVIUM (U. Ord.-Lr. Sil.)-"exotic" pebbles in clastic matrix; shale-chip gravel; sheared clay and quartz veins (fault gouge). Locally preserved and <0.3 m thick.

MARTINSBURG FM (Md.-Up. Ord.)-interbedded slate, shale and graywacke. Greater than 3000 m thick.

The contact between the Bloomsburg Red Beds and Shawangunk Formation has been traced without complication from eastern Pennsylvania to Port Jervis, NY (Stops 1A & 1B). Between Wurtsboro and Ellenville, NY, red beds and gray sandstone overlie the Shawangunk and, because of a similar succession of red and gray rocks at High Falls, NY, have been identified as, respectively, the High Falls Shale and Binnewater Sandstone by some workers (Gray, 1961; Smith, 1967). Detailed mapping, however, indicates that these red-gray rocks (Stops 5 & 6B) are facies ("tongues") of the Bloomsburg Red Beds and Shawangunk Formation (Fig. 3), not the High Falls and Binnewater. At Wurtsboro (Stop 6A), the High Falls Shale clearly occurs above the Shawangunk tongue. The Bloomsburg tongue gradually thins northeastward and changes in color from red to gray. The name "Guymard Quartzite" was used by Bryant (1926) for some of the gray Bloomsburg tongue rocks. This unit, like the "Otisville Shale," is unmappable and Epstein and Lyttle (1987) conclude that it also should be abandoned.

The rocks in the Shawangunk tongue are unlike typical quartzites of the Shawangunk Formation in that they are finer, better sorted and rounded, and more distinctly cross-bedded (Stops 5 & 6B). Some of the conglomerate layers in the Shawangunk tongue are similar to those in the Green Pond outlier (located about 40 km southeast of the main outcrop belt). This led Epstein and Lyttle (1987) to suggest that the Shawangunk tongue thickens in that direction to encompass most of the section in the outlier. To the southwest, the Shawangunk tongue pinches out into the Bloomsburg Red Beds (Fig. 3).

The High Falls Shale at High Falls, NY, contains red beds similar to those of the Bloomsburg tongue but also is characterized by a dolostone, fine limestone and shale facies with abundant ripple marks and dessication cracks. The similarity of those rocks to rocks in the Poxono Island Formation suggests that they probably are facies equivalents. Both formations are poorly exposed and the nature of the facies change has not been defined. Similarly, the cross-bedded sandstones of the Binnewater pinchout to the southwest (Rickard, 1962; Waines, 1976) into the Poxono Island Formation (Fig. 3). Thus the Binnewater, High Falls and Poxono Island are facies of a complex mixed carbonate-siliciclastic marginal marine sequence. As a consequence, the name "High Falls Shale" is incorrectly used on the New Jersey State geologic map (Lewis and Kummel, 1912) for rocks that should be referred to as the Bloomsburg Red Beds.

#### Enigmatic Diamictite

In southeastern New York, the Taconic unconformity (Stops 1B, 2 & 4) between the Martinsburg Formation (late Middle to early Late Ord.) and the overlying Shawangunk Formation (middle Sil.) represents about 10 to 30 million years, nearly the duration of the entire Silurian Period itself. The only apparent records of this period of time are a thin diamictite (Stop 2) and a shale-chip gravel (Stop 4), both patchily preserved beneath the basal unconformity of the Shawangunk Formation. The diamictite, generally less than 30 cm thick, is a mixture of angular to rounded clasts in a sand-silt matrix, dark yellowish orange in color. The clasts consist of fragments of the Martinsburg, quartz pebbles similar to those in the basal Shawangunk and, most interestingly, exotic pebbles that are dissimilar to rock types immediately above or below the unconformity. The source of these pebbles is enigmatic. The shale-chip gravel has been observed only at Stop 4 and consists of semi-consolidated, moderately sorted shale fragments derived from the underlying Martinsburg.

These deposits add an interesting footnote to Late Ordovician paleogeography in that they are evidence for the development of a 'colluvium' on the uplifted and subaerially exposed Martinsburg shales and graywackes. Subsequent pre-Shawangunk erosion resulted in the deposits being preserved only as thin remnants. The source of the exotic pebbles is no longer exposed nearby. Perhaps it was in Taconic nappes and later removed by erosion.

## FACIES DESCRIPTIONS AND INTERPRETATIONS

This field trip will deal primarily with the clastic rocks above the Shawangunk Formation and with the puzzling diamictite-colluvium preserved beneath the Taconic unconformity.

The paleoflow data (Fig. 4) and facies characteristics of the Bloomsburg and Shawangunk tongues and High Falls Formation (see stop discussions) indicate deposition in intertidal to subtidal environments. The facies succession indicates an overall transgressive event from the Shawangunk Formation (braided fluvial) through the Bloomsburg (intertidal flats and channels) and Shawangunk (lower intertidal to subtidal sand bodies) tongues. A slight regression marks the lower part of the High Falls Formation (intertidal flats and channels) with resumption of the transgression in the upper part of the High Falls Formation (lower intertidal and subtidal sands) and subsequent development of the Early Devonian carbonate shelf.

Because (1) tectonism had ceased (thereby eliminating tectonically driven rapid uplift or basin subsidence) and (2) climate was for the most part constant---dry and hot given the low-latitude paleoreconstructions of Scotese et al. (1979) and Ziegler et al. (1977)---which in combination with (1) suggests no sudden changes in sedimentation rate, we tentatively infer that sea level changes were the dominant control on the transgression-regression-transgression cycle described above. Given the well-documented hierarchy of sea-level cycles and allostratigraphic correlations for Lower Silurian strata in the Appalachian Basin (Brett and Goodman, 1987; Cotter, 1988; Duke, 1987), it is tempting to suggest that the fining-upward cycles of the Bloomsburg (Fig. 5) are in part also related to high frequency changes in sea level. However, our desire is tempered because (1) the sandstone bodies in the Bloomsburg are laterally discontinuous and (2) accurate correlations to more basinal equivalents have yet to be established.

Nonetheless, we offer two 'end-member' hypotheses as possible explanations of the stratigraphic succession. (1) A state of equilibrium existed among subsidence, sea-level change and sedimentation so that 'static,' vertical aggradation occurred. The fining-upward cycles simply record the lateral migration of tidal channels through intertidal flats (the Clinton Group in eastern Pennsylvania was interpreted thusly by Smith, 1968). (2) The mostly 1-3 m thick cycles (Fig. 5) are due to high-frequency sea level changes and record the displacement during rapid sea level rise of mid-intertidal flat areas over finer, upper intertidal flats. In both scenarios, the Shawangunk tongue represents a transgressive apex (subtidal sands over intertidal flats and channels) prior to the slight sea level drop during lower High Falls time (return of intertidal flats and sands) followed by a continuous rise of sea level. We welcome any suggestions or insights you may have.

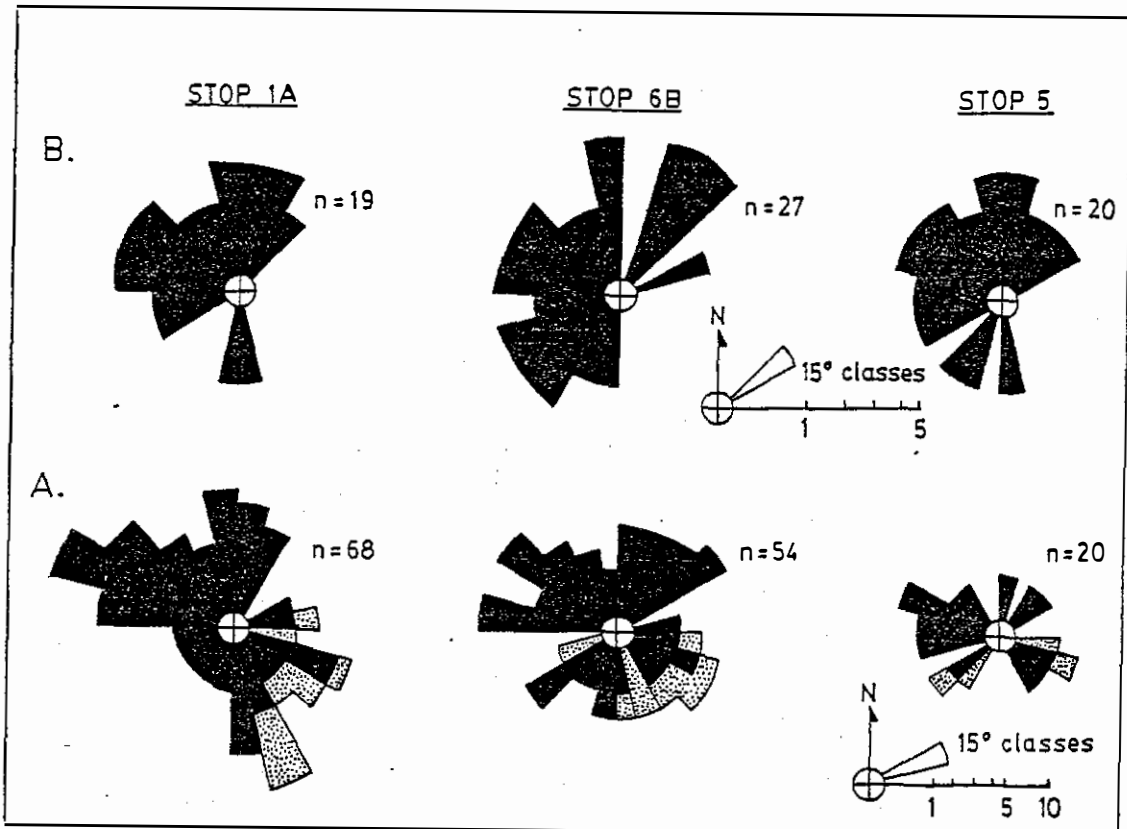

Figure 4. Equal area rosettes. A. Bloomsburg tongue data. Solid pattern-trough axes and edges and lateral accretion surfaces; stippled pattern-small-scale trough cross-strata. B. Shawangunk tongue data. Solid pattern-trough axes and erosive edges.

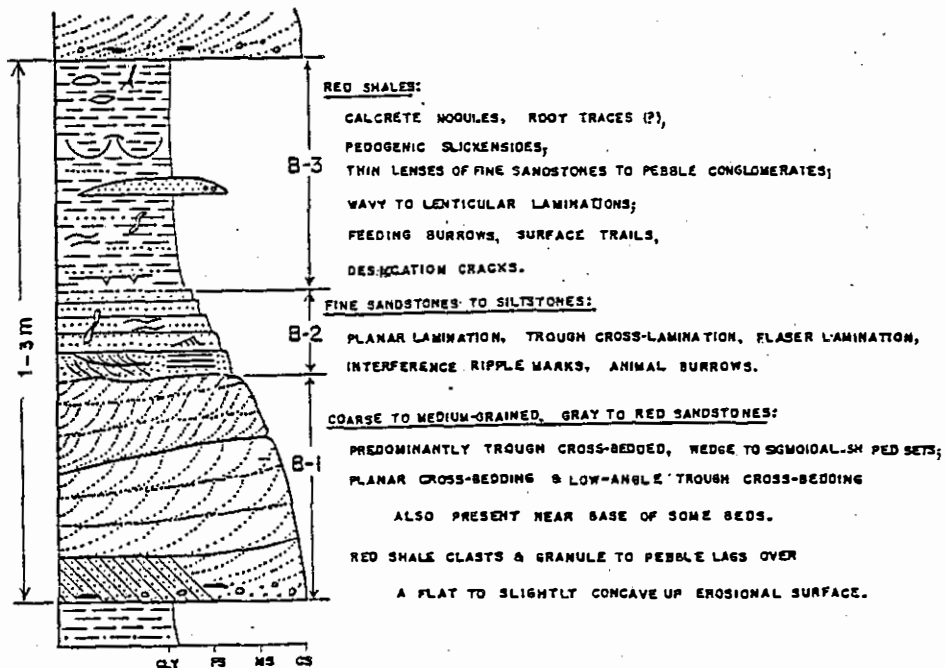

Figure 5. Idealized fining-upward cycle in the Bloomsburg Red Beds. B-1-tidal channel. B-2-3-intertidal flats and paleosols.

## ACKNOWLEDGMENTS

We thank E. Cotter, R. C. McDowell and D. Weiss for their reviews which improved this manuscript.

## REFERENCES CITED

- Bryant, W.L., 1926, On the structure of Palaeaspis and on the occurrence in the United States of fossil fishes belonging to the Pteraspidae: Proc. Amer. Philos. Soc., v. 65, p. 256-326.
- Cotter, E., 1988, Hierarchy of sea-level cycles in the medial Silurian siliciclastic succession of Pennsylvania: Geology, v. 16, p. 242-245.
- Duke, W.L., 1987, Revised internal stratigraphy of the Medina Formation in outcrop, in, Duke, W.L., ed., Sedimentology, stratigraphy and ichnology of the Lower Silurian Medina Formation in New York and Ontario: SEPM Eastern Section 1987 Ann. Meeting and Guidebook, p. 16-30.
- Epstein, J.B. and Epstein, A.G., 1967, Geology in the region of the Delaware to Lehigh Water Gaps-Field Conference of PA Geologists, 32d, East Stroudsburg, Guidebook: Pennsylvania Geological Survey, Harrisburg, PA, 89 p.
- and -----, 1972, The Shawangunk Formation (Upper Ordovician? to Middle Silurian) in eastern Pennsylvania: U.S. Geological Survey Professional Paper 744, 45 p.
- Epstein, J.B. and Lyttle, P.T., 1987, Structure and stratigraphy above, below and within the Taconic unconformity, southeastern New York, in, Waines, R.H., ed., 59th Meeting NYSGA, New Paltz, NY: Fieldtrip and Guidebook, p. C1-C78.
- Gray, C., 1961, Zinc and lead deposits of Shawangunk Mountains, New York: New York Academy of Sciences, v. 23, p. 315-331.
- Hartnagel, C.A., 1905, Notes on the Siluric or Ontario section of eastern New York: New York State Museum Bull. 80, p. 342-358.
- Klein, G. deV., 1985, Intertidal flats and tidal deltas, in, Davis, R.A., ed., Coastal Sedimentary Environments, 2d Ed.: Springer Verlag, New York, p. 187-224.
- Lewis, J.V. and Kummel, H., 1910-12, Geologic map of New Jersey, revised by M.E. Johnson, 1950, 1:250000.
- Middleton, G.V., 1987, Geologic setting of the northern Appalachian Basin during the Early Silurian, in, Duke, W.L., ed., Sedimentology, stratigraphy and ichnology of the Lower Silurian Medina Formation in New York and Ontario: SEPM Eastern Section 1987 Ann. Meeting and Guidebook, p. 1-15.
- Rickard, L.V., 1962, Late Cayugan (Upper Silurian) and Heldebergian (Lower Devonian) Stratigraphy of New York: New York State Museum Bull. 386, 157 p.
- Scotese, C.R., et al., 1979, Paleozoic base maps: J. Geol., v. 87, p. 217-277.
- Smith, N.D., 1967, A stratigraphic and sedimentologic analysis of some Lower and Middle Silurian clastic rocks of the north-central Appalachians: unpub. Ph.D., Brown Univ., Providence, RI, 195 p.
- , 1968, Cyclic sedimentation in Silurian intertidal sequence in eastern Pennsylvania: J. Sed. Pet., v. 38, p. 1301-1304.



- Swartz, C.K. and Swartz, F.M., 1931. Early Silurian formations of southeastern Pennsylvania: G.S.A. Bull., v. 42, p. 621-661.
- Waines, R.H., 1976, Stratigraphy and paleontology of the Binnewater Sandstone from Accord to Wilbur, New York. in, Johnson, J.H., ed., NYSGA 49th Ann. Meeting, Poughkeepsie, NY: Field Trip Guidebook, p. B3-1 to B3-15.
- Yeakel, L.S., Jr., 1962. Tuscarora, Juniata and Bald Eagle paleocurrents and paleogeography in the central Appalachians: G.S.A. Bull., v. 73, p. 1515-1539.
- Ziegler, A.M., et al., 1977. Silurian continental distributions, paleogeography, climatology and biogeography: Tectonophysics, v. 40, p. 13-51.

ROAD LOG FOR STRATIGRAPHY AND SEDIMENTOLOGY OF MIDDLE AND UPPER SILURIAN ROCKS AND AN ENIGMATIC DIAMICTITE, SOUTHEASTERN NEW YORK

| Cumul. Milage | Miles from Last Point | ROUTE DESCRIPTION   |
|---------------|-----------------------|---|
| 0             | 0                     | Proceed SE along Bedford Ave. from South St. intersection at O.C.C.C. Campus, Middleton, NY.  |
| 0.4           | 0.4                   | Traffic light, turn right onto NY 17M.  |
| 1.6           | 1.2                   | Turn right onto I84 West. For the next 12 miles there are scattered outcrops of Martinsburg Fm.   |
| 13.2          | 11.6                  | Martinsburg-Shawangunk contact to left.   |
| 14.0          | 0.8                   | Parking area to right affords an excellent view of the Pocono Plateau; intermediate ridges are in the Md. Dev. Hamilton Gp; Neversink Valley is floored by Up. Sil.-Low. Dev. rocks.  |
| 16.3          | 2.3                   | Take Exit 1, US6 West. Turn left onto US6 West; at traffic light turn left towards I84 East; Mid. Dev. Esopus Fm on right. Go under overpass and turn left on I84 East. Ascent is on Wisconsinian till covering Up. Sil.-Low. Dev. rocks. |
| 19.3          | 3.0                   | Depart vehicles at beginning of outcrop on right and have drivers continue on (0.6 miles) to rest area on right (or drive your vehicle to rest area and walk back down the exposure).   |

STOP 1A (PORT JERVIS AREA). BLOOMSBURG RED BEDS.

Epstein and Lyttle (1987) estimate that the Bloomsburg Red Beds is about 335 m thick near Port Jervis, NY. These strata can be traced continuously across New Jersey from Pennsylvania with little facies change. The Shawangunk tongue, which separates the main body of the Bloomsburg from the Bloomsburg tongue to the northeast, thins to a feather edge at this locality and is unmappable at a scale of 1:24000. For the sake of brevity, the description and interpretation of the Bloomsburg tongue will be given at this stop and at Stop 5 for the Shawangunk tongue.

Alcala measured the section from the top of the Shawangunk Formation to the top of the Shawangunk tongue (Fig. 6). The Shawangunk tongue is only 5 m thick. It is described in detail at Stops 5 and 6B. The Bloomsburg between those two units is 65 m thick and consists of 45 fining upward cycles. Discontinuous pebbly lags occur above a flat to scoured erosive base which is overlain by fine to coarse quartzose sandstones and lithic wackes. These in turn grade upward into reddish or grayish fine sandstones and siltstones generally overlain by blocky red mudstones. Thin, discontinuous stringers of coarser sandstones are common in these finer clastics.

The fine to coarse sandstones above the erosive base consist of several centimeters- to decimeters-thick cosets of trough cross-beds arranged in sigmoidal- and wedge-shaped bundles bounded by lateral accretion surfaces. The cosets generally thin upward. Planar cross-bedding and reactivation surfaces are present locally. Interference ripples are common on bed tops. The laterally continuous appearance of these sandstone beds is deceiving. They actually are broad, shallow channels that thin and pinchout into finer clastics (this will be seen from the top of the outcrop from a near normal-to-paleoflow view across I-84).

The overlying red and gray fine sandstones and siltstones contain abundant small-scale trough cross-bedding and flat lamination. Flaser and lenticular bedding, reactivation surfaces, interference ripples and burrows are common locally. The red mudstones generally contain desiccation cracks, horizontal and sub-vertical burrows and possible root traces. Calcrete zones and pedogenic slickensides are present in places.

These facies characteristics coupled with the paleocurrent data (Fig. 4) lead us to conclude that the Bloomsburg Red Beds record deposition in an intertidal environment. The broadly-channeled, coarse sandstones were tidal channels that migrated through a finer detrital intertidal flat. Paleosols developed locally in a dry climate as indicated by the calcrete zones and desiccation cracks. The thin, coarse sandstone stringers in the shales probably record exceptional tidal or storm events.

From the paleoflow data (Fig. 4), it is evident that ebb flows were dominant. The larger-scale trough cross-beds and lateral accretion surfaces make up the WNW-mode whereas the ESE-mode is more dependent on the presence of smaller bed forms. The lateral accretion surfaces and sigmoidal-shaped bundles indicate that tidal currents continuously mobilized the sandy substrate in a general WNW-ESE trend. These observations corresponds nicely with the pattern of tidal forcing one would expect given the Silurian paleogeographic reconstructions of Scotese et al. (1979) and Ziegler et al (1977) showing the Taconic highlands as a NE-trending belt that had an epeiric sea to the west (Fig. 7).

We interpret the strong NNE mode on the rosette as representing a dominant lateral migration direction of the tidal channels due to the influence of a NE-flowing longshore current. Again this fits well with the paleoclimatic inferences of Ziegler et al. (1977) which indicate a southern, low-latitude high pressure system to the west of the Taconic highlands (Fig. 7); the counterclockwise circulation of surface winds associated with this high would force a NE-flowing longshore current along the western edge of the highlands. Thus, the paleoflow data indicate a dominant WNW ebb tide and a weaker ESE flood tide with a moderately influential NNE-flowing longshore current.

Unfortunately, the exposures are not quite good enough to determine spring-neap cycles. However, many of the coarser sandstones appear to have bundles of well-developed cosets and lesser-developed cosets which we have tentatively interpreted as full-vortex and slackening structures, respectively.

|      |     |   |
|------|-----|---|
| 19.9 | 0.6 | Reboard vehicles in rest area; continue on I84. |
| 20.7 | 0.8 | Park vehicles on shoulder to right.             |

STOP 1B (PORT JERVIS AREA). TACONIC UNCONFORMITY AND BASAL SHAWANGUNK FORMATION.

The Shawangunk Formation is interpreted as recording a NW-flowing braided fluvial system draining the Taconic highlands (Yeakel, 1962; Smith, 1967; Epstein and Epstein, 1967, 1972). The facies and paleoflow data from this exposure (which is representative of the basal Shawangunk throughout the area) support that interpretation (at least for the basal part of the formation); thick-bedded, massive to large-scale trough cross-bedded, quartz-pebble conglomerate and coarse quartzite yielding uniquadrant paleocurrent rosettes (Fig. 8).

Here, the Shawangunk rests unconformably on shale and graywacke of the Martinsburg Formation. The angular discordance is 5°. Along the contact is a 5 to 15 cm thick fault gouge containing angular Martinsburg fragments in a dark-yellowish orange clay matrix. Thus, this contact also represents a zone of tectonic displacement, the amount of which is not known. For a complete discussion of the relative effects of the Taconic and Alleghanian orogenies, see Epstein and Lyttle (1987).

|      |     |   |
|------|-----|---|
|      |     | Reboard vehicles and continue on I84.   |
| 21.4 | 0.7 | Take Mountain Rd (Exit 2); at stop sign turn: right; you will travel along south slope of Shawangunk Mtn; note occasional Martinsburg outcrops. |
| 26.4 | 5.0 | Bear left on Mountain Road (Rte. 73).   |
| 29.6 | 3.2 | Otisville; turn left onto Field Road.   |
| 30.1 | 0.5 | Turn left onto Walker Street.   |
| 30.5 | 0.4 | Stop sign; turn left onto State Street (NY 211).  |
| 30.7 | 0.2 | Park vehicles in broad open area on left.   |

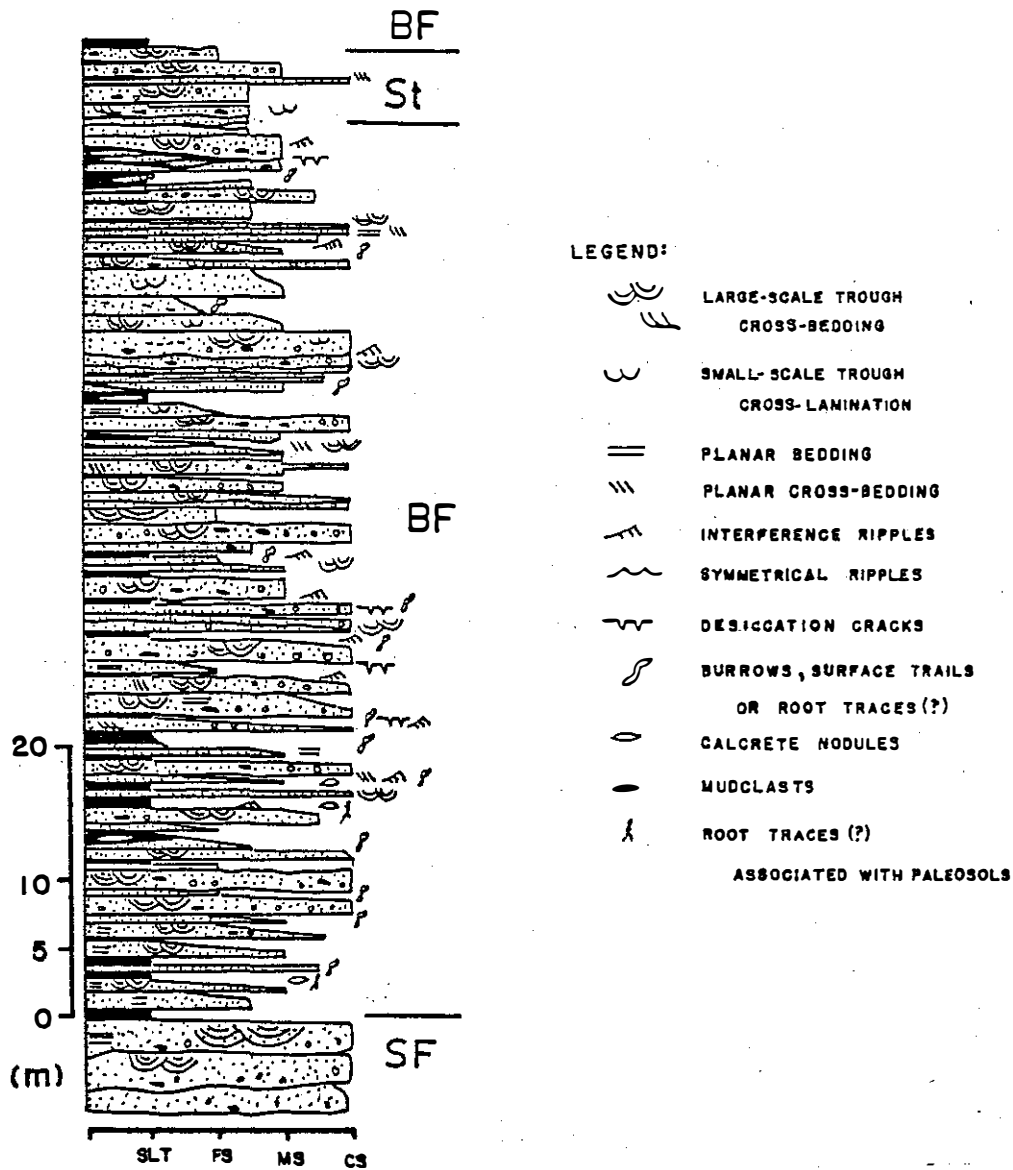

Figure 6. Measured section along I-84 east of Port Jervis, NY. BF-Bloomsburg Red Beds; SF-Shawangunk Fm; St-Shawangunk tongue.

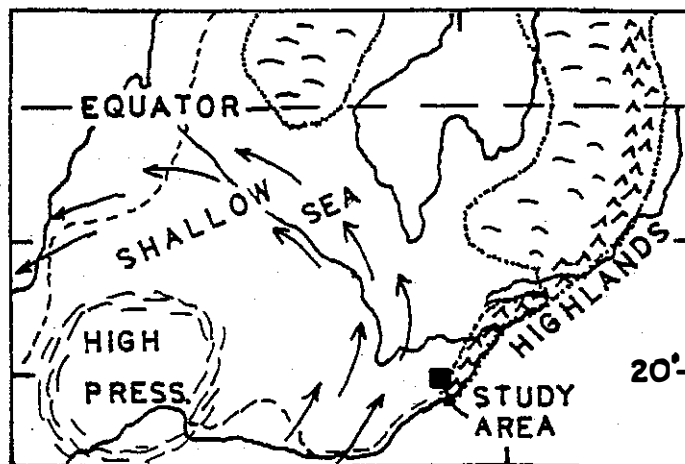

Figure 7. Middle Silurian paleogeography after Ziegler et al. (1977). Arrows indicate circulation pattern of surface winds.

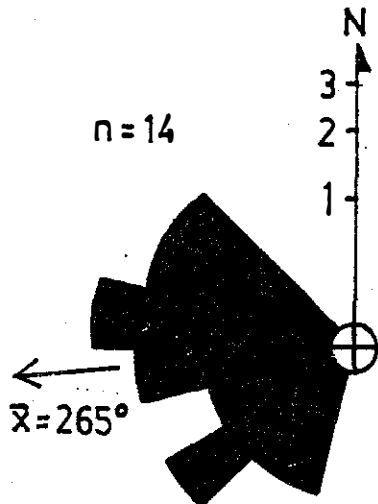

Figure 8. Equal area rosette constructed from trough axes and erosive edges measured in the basal part of the Shawangunk Formation at Stop 1B.

#### STOP 2 (OTISVILLE). DIAMICTITE AT THE TACONIC UNCONFORMITY.

This classic exposure of the Taconic unconformity along the railroad cut was visited on the 59th NYSGA Meeting (Epstein and Lyttle, 1987). This discussion is a summary of that visit.

The quarry across the road is in the Shawangunk Formation; it is about 2 km along strike from the type locality of the "Otisville Shale" of Swartz and Swartz (1931). As is evident, shale is meager. The "Otisville" is poorly-defined and should be discarded.

The shales and siltstones of the Martinsburg dip moderately to the northwest, whereas, above the unconformity, the quartz-pebble conglomerate of the Shawangunk dips  $16^{\circ}$  less. The basal surface of the Shawangunk is irregular and displays downward projecting mullions having a few centimeters of relief and spacings up to a few decimeters. Bed-parallel shearing is developed in places above the unconformity.

Along the contact is a diamictite as much as 30 cm thick with sharp, unconformable upper and lower contacts. Within the mud matrix are angular clasts of the Martinsburg (in places large parts of the Martinsburg appear to have been bodily incorporated into this zone) as well as angular to rounded "exotic" pebbles not present in the underlying bedrock: clean and pyritic quartz arenite, feldspathic and chloritic sandstone, cross-laminated feldspathic conglomeratic quartzite, siliceous and micaceous siltstone and red siltstone. Weathering rinds and pits are present on some of the pebbles and, along with the rounding, are evidence for subaerial transport and exposure prior to deposition. The above indicates that the diamictite is a product of mass wasting, possibly a colluvial gravel.

Also in this zone is a grayish gouge with slickensided quartz veins. This gouge and the mullions are typical of many of the Martinsburg-Shawangunk contacts in southeastern New York and indicate that the unconformity is a plane of movement, the displacement along which is not known.

|      |     |   |
|------|-----|---|
|      |     | Reboard vehicles and turn left onto NY 211.   |
| 30.8 | 0.1 | Almost immediately turn right onto Orange County 61.; Shawangunk Fm to right.   |
| 32.9 | 2.1 | Stop sign; turn right onto US 209 North.  |
| 39.7 | 6.8 | Wurtsboro; proceed past traffic light.  |
| 42.0 | 2.3 | Wurtsboro airport; Shawangunk mine (Pb-Zn) on top of Shawangunk Mtn to right (Gray, 1961).  |
| 46.9 | 4.9 | Wisconsinian moraine; it is over 3 miles wide.  |
| 50.8 | 7.2 | Mount Marion Fm to left; deposits of glacial Lake Warwarsing to right.  |
| 51.8 | 1.0 | Traffic light in Ellenville; turn right on NY 52 East (Center Street).  |
| 52.7 | 0.9 | Stop sign; bear right on NY 52. You will cross North Gulley (Bloomsburg & Shawangunk tongues to left) and proceed up Shawangunk Mtn; exposures of Shawangunk Fm will be on your left. |
| 55.7 | 3.0 | "Shale unit" within Shawangunk Fm on left.  |
| 56.8 | 1.1 | Turn left towards Cragmoor and Ice Caves Mountain National Landmark.  |
| 58.2 | 1.4 | Cragmoor; turn left just before Post Office onto Meadow Lane.   |
| 58.5 | 0.3 | Turn right at "T."  |
| 58.7 | 0.2 | Turn left at "T."   |
| 58.9 | 0.2 | Park vehicles in parking area and follow path to Bear Hill. After lunch return to vehicles.   |

### STOP 3 (BEAR HILL). LUNCH AND SHAWANGUNK FORMATION CROSS-BEDS.

These nearly flat-lying beds of the lower part of the Shawangunk Formation are near the crest of the Ellenville arch, a broad, open fold of Alleghanian age (Epstein and Lyttle, 1987). The basal 30 m of the formation are exposed here and consist primarily of quartz-pebble conglomerate and medium to pebbly quartzite composed of decimeter-scale cosets of trough cross-bedding. A well-developed joint pattern and numerous exposures of bedding surfaces afford an excellent opportunity to examine the relationship between quasi-3-D views and plan views of trough cross-bedding. These exposures can be used to discuss the 'proper' methods of obtaining paleoflow data from troughs.

|      |     |  |
|------|-----|--|
|      |     | Reboard vehicles and continue past parking area.                   |
| 59.1 | 0.2 | Bear right at intersection.  |
| 59.2 | 0.1 | Turn right onto Meadow Lane  |
| 59.3 | 0.1 | Stop sign; turn right (downhill).                                  |
| 60.7 | 1.4 | Stop sign; turn right onto NY 52.                                  |
| 64.5 | 3.8 | Turn right onto South Gulley road.                                 |
| 65.3 | 0.8 | Turn left onto Mt. Meenhaga Road; Martinsburg Fm exposure to left. |

65.7      0.4      Park vehicles in open area at bend in road and walk 100 m back down road to Stop 4.

STOP 4 (ELLENVILLE). SHALE-CHIP GRAVEL AT TACONIC UNCONFORMITY.

This exposure also was visited on the 59th NYSGA Meeting (Epstein and Lyttle, 1987) but it is a problematic exposure worthy of further puzzlement. Your opinions are encouraged.

The basal Shawangunk forms a slight overhang which affords a view of an in-place, shale-chip gravel developed beneath the unconformity. The shale-chip gravel is at least 60 cm thick and consists of very well sorted shale chips about 3 cm in length derived from the underlying Martinsburg (exposed about 6 m below this outcrop). It is crudely foliated parallel to bedding in the Shawangunk. This shale-chip gravel is similar to those of Pleistocene age derived from Paleozoic shales in many areas in Pennsylvania and New Jersey.

The excellent sorting suggests winnowing of the gravel during transport. This gravel and the diamictite observed at Stop 2, indicate that the Martinsburg surface, uplifted during the Taconic orogeny, was subaerially exposed and covered by colluvium and gravels. Much of this material was subsequently removed by erosion and the remnants were buried by the Shawangunk conglomerates. There are no known nearby sources for the exotic pebbles in the diamictite. As stated earlier, it is possible that they were derived from now-eroded Taconic nappes.

Reboard vehicles and go back down Mt. Meenhaga Rd  
 66.0      0.4      Turn right onto South Gulley Road.  
 66.8      0.8      Stop sign; turn right onto NY 52.  
 67.2      0.3      Turn left and immediately right into parking area.

STOP 5 (ELLENVILLE). BLOOMSBURG AND SHAWANGUNK TONGUES.

This section was measured by Alcalá. The Bloomsburg tongue is 48 m thick and consists of 37 fining upward cycles (Fig. 9). Seven meters of the Shawangunk tongue are exposed. The contact between the Shawangunk Fm and Bloomsburg tongue is gradational as is the contact between the two tongues.

The fining-upward cycles in the Bloomsburg tongue are similar to but contain more shale and mudstone than the Bloomsburg strata seen at Stop 1A. The sandstones forming the basal parts of cycles are the same. Quartz and lithic wackes that consist of sets and cosets of trough cross-strata are arranged in sigmoidal-shaped bundles commonly bounded by lateral accretion surfaces. Given the same facies characteristics and paleoflow trends (Fig. 4), we interpret this section similarly. The dominant WNW-ESE bipolar rosettes indicate tidal flow. The data obtained from the larger bed forms again suggest a stonger ebb tide relative to the flood tide. The NNE mode indicates the continuing influence of

northeast flowing longshore currents in forcing a preferred NNE migration direction of tidal channels. The finer clastics represent the intertidal flats. We interpret their greater proportion here as indicating deposition primarily in upper intertidal flat areas.

The first tabular-appearing quartz arenite bed marks the base of the Shawangunk tongue which consists predominantly of thick-bedded, fine to medium quartz arenites with minor greenish shale and rare red shale. Shales occur as thin partings or layers up to 20 cm in thickness. Pebbly quartzite occurs in places (such a bed occurs about 4 m above the base here and at the section near Wurtsboro). Bases of beds are erosive and flat to shallowly scoured and pebbly lags occur locally. Trough cross-bedding is common and occurs in sets and cosets 0.1 to 1 m thick. Planar cross-bedding and flat lamination occur locally; some of the finer sandstones contain small-scale cross-stratification. In all cases, laminations consist of alternating

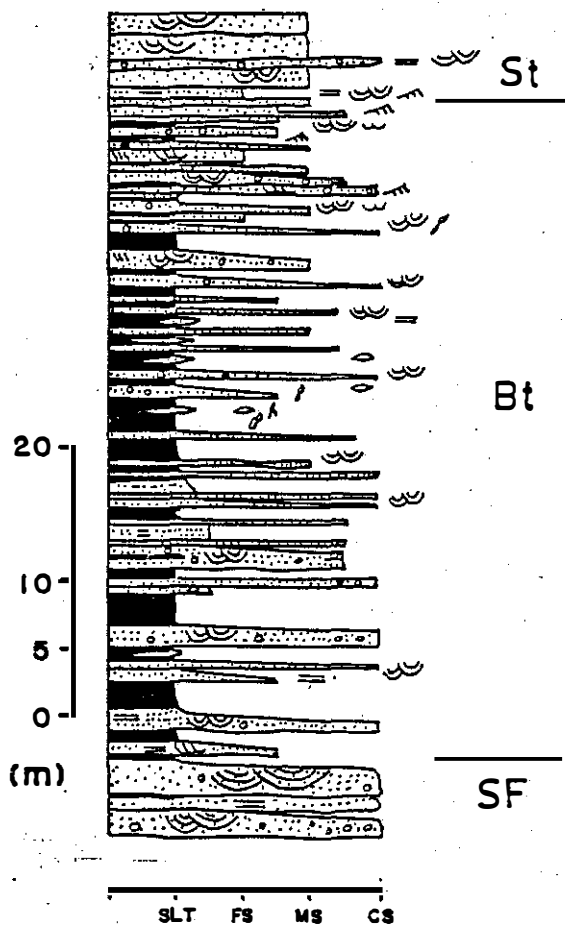

Figure 9. Measured section of Bloomsburg (Bt) and Shawangunk (St) tongues in North Gulley near Ellenville, NY. SF-Shawangunk Fm. See Figure 6 for explanation of symbols.



light-dark couplets. Some of the foresets are defined by flat mud clasts. Interference ripples and, rarely, trails and burrows can be observed on some bed surfaces.

On the basis of the facies characteristics and paleocurrent data (Fig. 4), we interpret the Shawangunk tongue as a subtidal (and possible lower intertidal) sand body. The clustering of flow data in the western hemisphere of the rosettes (i.e., from  $180^{\circ}$  to  $360^{\circ}$ ) indicates primarily offshore-directed transport, probably by strong ebb tides and possibly by rip and storm currents (note, however, that no hummocky or swaley cross-stratification has been observed to support a storm influence). The NNE mode indicates sediment transport by longshore currents. We interpret the 'clean' quartz arenitic character of these sandstones as resulting from selective sorting by marine currents (the coarser, 'dirtier' sands were 'locked-up' in the tidal channels of the Bloomsburg). The presence of interference ripples and rare trace fossils further supports this interpretation.

Modern tidal flats display a progressive facies change. Upper intertidal areas are finer-grained, less and smaller channeled relative to the well-channeled, mid intertidal areas whereas lower intertidal areas are mostly sandy with less fines; adjacent subtidal zones are sandy (Klein, 1985). Examination of the measured sections (Figs. 6, 9 & 11) indicates such a trend. The lower part of the Bloomsburg tongue contains more fines than does the uppermost part, i.e., deposition initially occurred in middle and upper areas of an intertidal environment with subsequent deposition in lower intertidal environments. As the transgressive event progressed, those deposits were covered by sandy subtidal deposits of the Shawangunk tongue.

|      |      |  |
|------|------|--|
|      |      | Reboard vehicles and turn left onto NY 52.   |
| 67.3 | 0.1  | Turn left onto Center Street.  |
| 68.2 | 0.9  | Traffic light; turn left onto US 209 South.  |
| 80.3 | 12.1 | Wurtsboro; continue past traffic light unless you would like a cold beer and a pastrami sandwich at Danny's. |
| 81.7 | 1.4  | Turn left onto NY 17 South towards New York City.  |
| 83.0 | 1.3  | Park vehicles on shoulder on right.  |

#### STOP 6A (WURTSBORO). HIGH FALLS SHALE.

The High Falls Shale and correlative Poxono Island Formation are poorly exposed in this area. The nearest exposures to this locality are 34 km to the northeast near Accord, NY and about a similar distance to the southwest in New Jersey. The sections at Stop 6 (A & B) were measured by Alcalá.

The section of the High Falls Shale is 10 m thick (Fig. 10), but it is incomplete (both contacts are covered). The High Falls consists of fine to medium quartzose sandstones with minor, laterally discontinuous greenish and reddish shale layers. Beds

are composed of large-scale trough cross-bedded sets and cosets as much as 80 cm thick. Lateral accretion surfaces and, less commonly, reactivation surfaces bound many of the sets. Planar cross-bedding, flat lamination, desiccation cracks, symmetrical ripples, and burrows and trails are moderately common. Bases of beds are flat but erosive and have local lags. Bed tops generally are mantled with interference ripples.

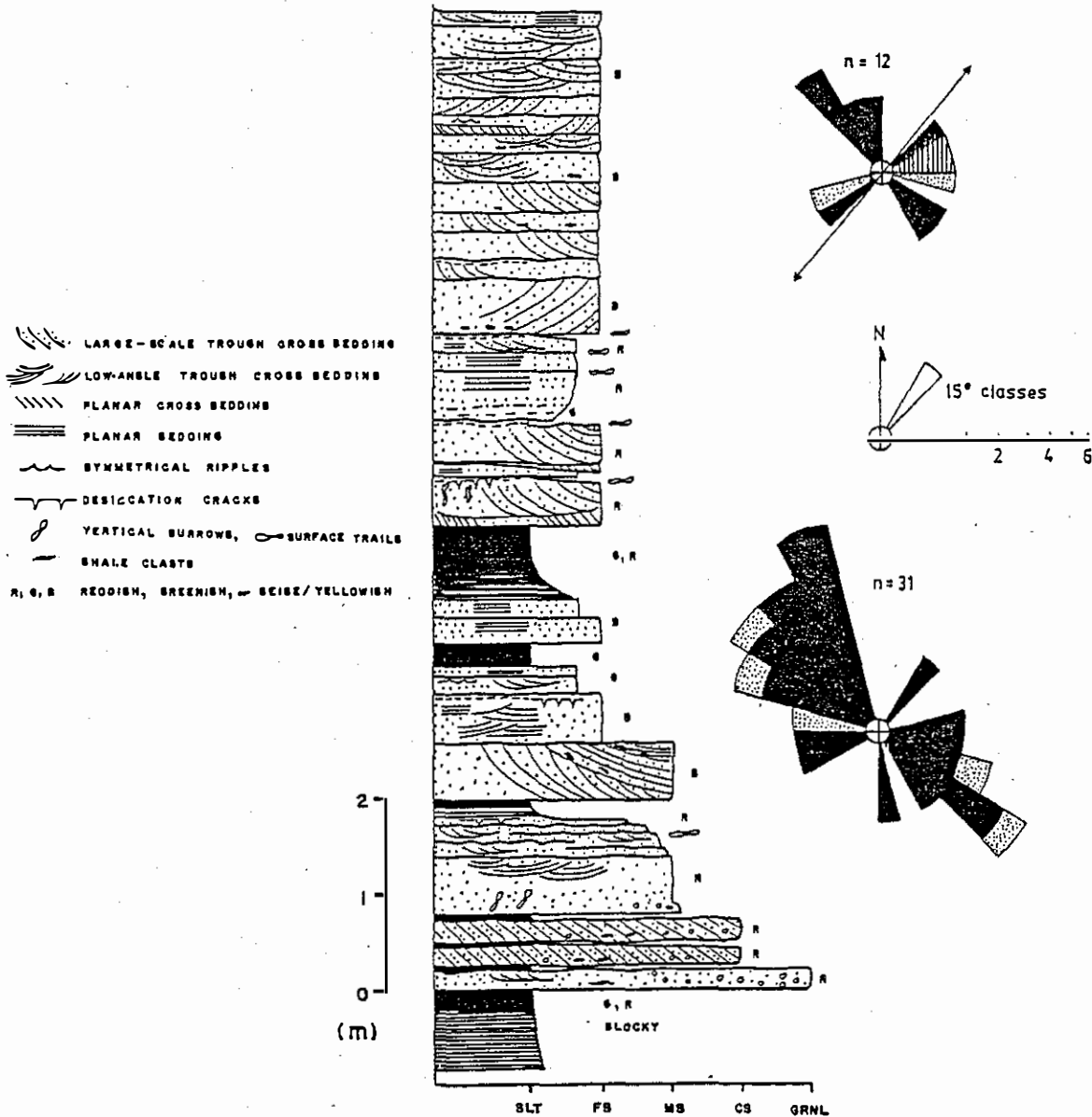

Figure 10. Measured section of the High Falls Formation along Rte. 17 near Wurtsboro, NY. Equal area paleocurrent rosettes: solid pattern-trough axes and edges; stippled pattern-small-scale trough cross-strata; vertical lines-planar cross-bedding. Double arrow represents average trend of three wave ripple crests.

Examination of the paleocurrent rosettes (Fig. 10) clearly indicates that these are tidal deposits. The sedimentary structures and composition suggest lower intertidal to subtidal settings. The WNW-directed ebb tide was dominant. A less-developed NE mode is once again interpreted as recording the influence of longshore currents. Curiously, these flows are rotated slightly clockwise relative to those of the Bloomsburg and Shawangunk tongues. We tentatively conclude that this probably indicates a slight reorientation of the paleostrandline to a more northeasterly direction. The NE-trend of wave ripple crests (Fig. 10) adds some credence to this speculation.

|      |     |  |
|------|-----|--|
|      |     | Reboard vehicles and continue along NY 17 South.             |
| 84.0 | 1.0 | Proceed past curve in road and park along shoulder on right. |

STOP 6B (WURTSBORO). BLOOMSBURG AND SHAWANGUNK TONGUES.

The Bloomsburg and Shawangunk tongues are best exposed at this locality which is a normal-to-paleoflow view. Contacts between the "tongues" and the underlying Shawangunk Fm are gradational. The Bloomsburg tongue is 58 m thick and consists of 41 fining-upward cycles (Fig. 11). The Shawangunk tongue is nearly complete (top contact is covered) and is 34 m in thickness. The facies here are similar to those observed at Stops 1A and 5 except that they are thicker and have more paleosol and caliche layers. Thus, given the same facies and paleoflow trends (Fig. 4), the same interpretation is proposed: the Bloomsburg tongue is an intertidal deposit recording WNW-ESE ebb-flood tides and the Shawangunk tongue is a subtidal deposit. Both "tongues" were influenced by a NNE-flowing longshore current.

|      |      |   |
|------|------|---|
|      |      | Reboard vehicles and continue along NY 17 South.  |
| 84.2 | 0.2  | We will pass the Taconic unconformity and a long exposure of Martinsburg Fm described by Epstein and Lyttle (1987, p. C-71-73); under overpass is a slump structure to the right. |
| 94.9 | 10.7 | Bear right onto I84 West and return home or to the O.C.C. Campus.   |

END OF TRIP. HAVE A SAFE JOURNEY HOME.

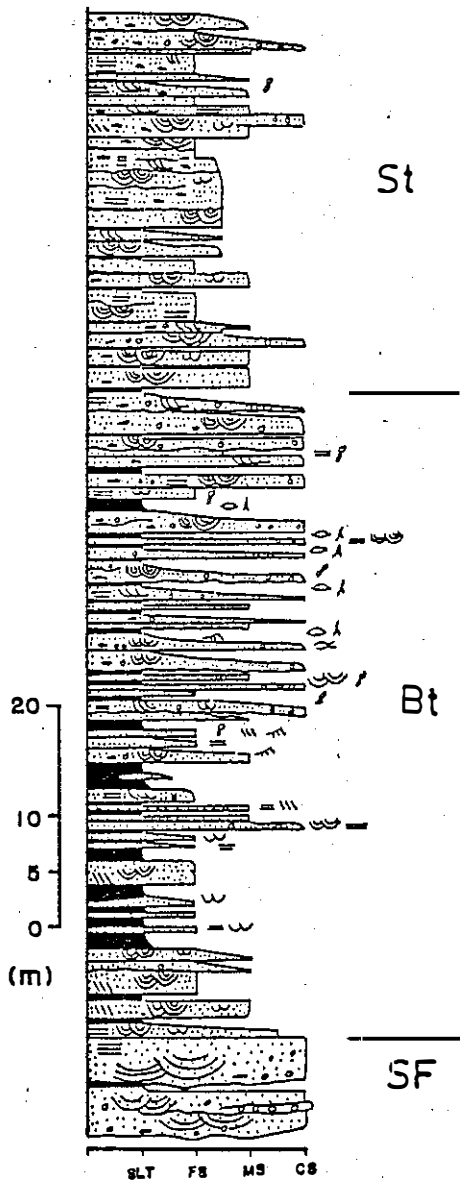

Figure 11. Measured section of the Bloomsburg (Bt) and Shawangunk (St) tongues along Rte. 17 near Wurtsboro, NY. SF-Shawangunk Formation. See Figure 6 for explanation of symbols.